

THE UNIVERSITY OF THE STATE OF NEW YORK

GRADE 4

ELEMENTARY-LEVEL SCIENCE TEST

WRITTEN TEST

MAY 2005

Student Name _____

School Name _____

Print your name and the name of your school on the lines above.

The test has two parts. Parts I and II are in this test booklet.

Part I contains 30 multiple-choice questions. Record your answers to these questions on the separate answer sheet. Use only a No. 2 pencil on your answer sheet.

Part II contains 10 open-ended questions. Write your answers to these questions in this test booklet.

You will have as much time as you need to answer the questions.

DO NOT TURN THIS PAGE UNTIL YOU ARE TOLD TO DO SO.

Copyright 2005

THE UNIVERSITY OF THE STATE OF NEW YORK
THE STATE EDUCATION DEPARTMENT
ALBANY, NEW YORK 12234

NO PART OF THIS TEST MAY BE REPRODUCED AND/OR TRANSMITTED BY ANY MEANS WITHOUT WRITTEN PERMISSION.

DIRECTIONS

There are 30 questions on Part I of this test. Each question is followed by three or four choices, labeled A through D. Read each question carefully. Decide which choice is the best answer. On the separate answer sheet, mark your answer in the row of circles for each question by filling in the circle that has the same letter as the answer you have chosen. Use a No. 2 pencil to mark the answer sheet.

Read Sample Question **S-1** below.

S-1 Frozen water is called

- A fog
- B ice
- C steam
- D vapor

The correct answer is **ice**, which is next to letter **B**. On your answer sheet, look at the box showing the row of answer circles for Sample Question **S-1**. See how the circle for letter **B** has been filled in.

Read Sample Question **S-2**. Mark your answer on the answer sheet in the box showing the row of answer circles for Sample Question **S-2**.

S-2 Which animal has wings?

- A bird
- B frog
- C mouse
- D rabbit

The correct answer is **bird**, which is next to letter **A**. On your answer sheet, you should have filled in circle **A**.

Answer all 30 questions on Part I of this test. Fill in only one circle for each question. Be sure to erase completely any answer you want to change. You may not know the answers to some of the questions, but do the best you can on each one.

When you have finished Part I, go on to Part II. Answer all of the questions in Part II in the space provided for each question.

Part I

- 1 Which example describes an organism taking in nutrients?
 - A a dog burying a bone
 - B a girl eating an apple
 - C an insect crawling on a leaf
 - D a boy planting tomatoes in a garden

- 2 Which characteristic is inherited rather than learned?
 - A telling a story
 - B saluting the flag
 - C having blue eyes
 - D riding a bicycle

- 3 What is the main function of scales on a fish?
 - A to protect the fish
 - B to attract predators
 - C to help the fish find food
 - D to help the fish breathe

- 4 Which behavior is an example of an animal adapting to a change in the environment?
 - A a squirrel climbing a tree
 - B a rabbit feeding its young
 - C a frog eating an insect
 - D a bird migrating south

Base your answers to questions 5 through 7 on the diagram of a food chain below and on your knowledge of science.

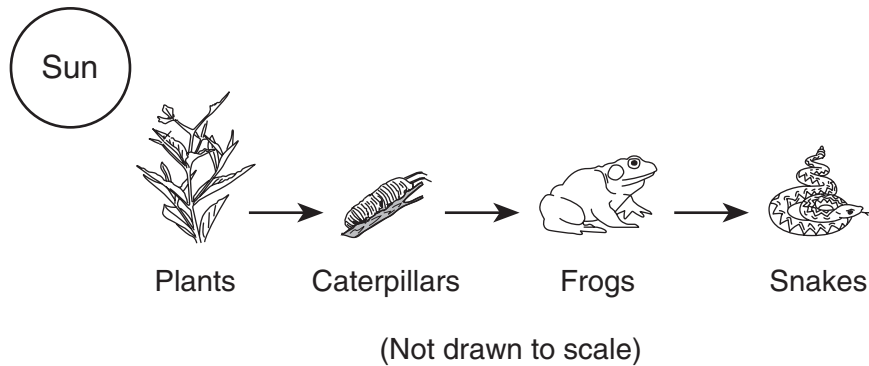

5 Which organisms in this food chain are needed for all the other organisms to survive?

- A caterpillars
- B frogs
- C plants
- D snakes

6 Which organisms in this food chain are predators?

- A plants and caterpillars
- B caterpillars and frogs
- C frogs and snakes
- D snakes and plants









Note that question 7 has only three choices.

7 If the population of snakes increases, the population of frogs will most likely

- A decrease
- B increase
- C remain the same

Base your answers to questions 8 through 10 on the chart below and on your knowledge of science. The chart shows the life span of several organisms.

Life Span of Several Organisms

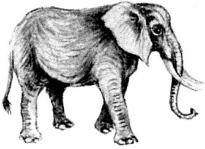
Pine trees					 Cedar of Lebanon	 Bristlecone pine
Flowering plants		 Common poppy	 Foxglove			 English oak
Arthropods (includes insects)	 Housefly	 Butterfly		 American lobster		
Mammals			 Red fox	 African elephant		
	1–30 days	1–12 months	1–10 years	10–100 years	100–1,000 years	Over 1,000 years

(Not drawn to scale)

8 What is the life span of an organism?

- A the stages of development of the organism
- B the length of time the organism lives
- C the basic needs of the organism
- D the life processes the organism performs

9 The life span of an African elephant is between

- A 1 minute and 1 day
- B 1 year and 10 years
- C 10 years and 100 years
- D 100 years and 1,000 years

10 Which organism has the longest life span?

- A red fox
- B common poppy
- C American lobster
- D bristlecone pine

11 Animals get energy for growth and repair from

- A soil
- B food
- C water
- D air

12 A dog opens its mouth and lets its tongue hang out. A human's body produces sweat. These are two ways that organisms may adjust to

- A cold temperatures
- B hot temperatures
- C a shortage of food
- D a shortage of drinking water

13 During which season of the year would a rabbit's fur be thickest?

- A fall
- B spring
- C summer
- D winter

14 Which animal is preparing for a seasonal change in the environment?

- A a bat flying at night
- B a deer drinking water
- C an owl eating a mouse
- D a squirrel storing nuts

15 An example of a **poor** health habit is

- A taking a bath or shower regularly
- B handwashing after using the bathroom
- C playing on a soccer team
- D eating candy instead of lunch

16 Which substance is usually found in nature as a liquid, solid, and gas?

- A water
- B rock
- C metal
- D glass

17 The map below shows weather conditions on a single day in the United States.

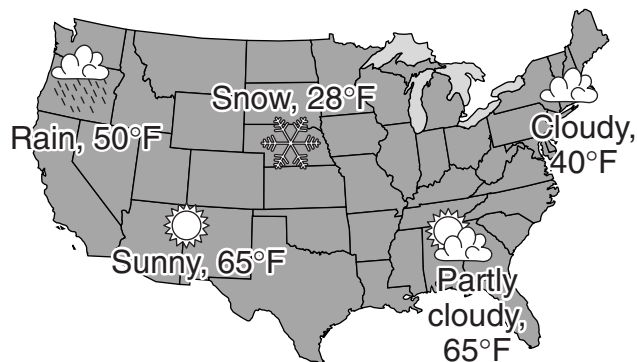

Which two types of precipitation are occurring?

- A high tides and low tides
- B rain and snow
- C sleet and hail
- D cloudy and sunny

- 18 In the diagram below, letters *A*, *B*, *C*, and *D* show processes in the water cycle.

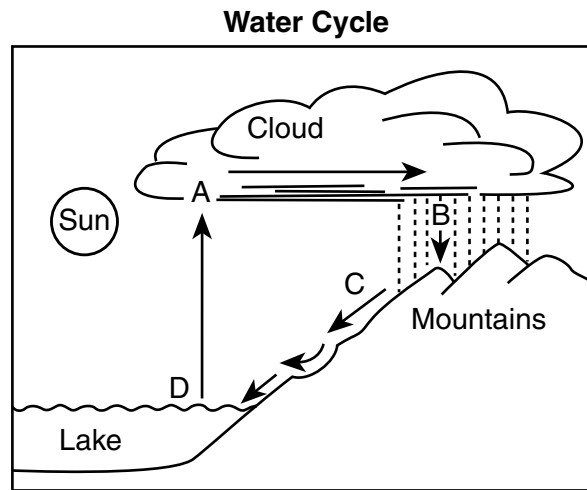

Which letter shows runoff?

- A *A*
- B *B*
- C *C*
- D *D*

- 19 A student is growing some plants for an experiment. She notices small white spots on the leaves. Which tool should she use to get a better look at the spots?

- A thermometer
- B hand lens
- C graduated cylinder
- D balance

- 20 What is one way to change water from a liquid to a solid?

- A decrease the temperature
- B increase the temperature
- C decrease the mass
- D increase the mass

21 The diagram below shows a river flowing through a valley.

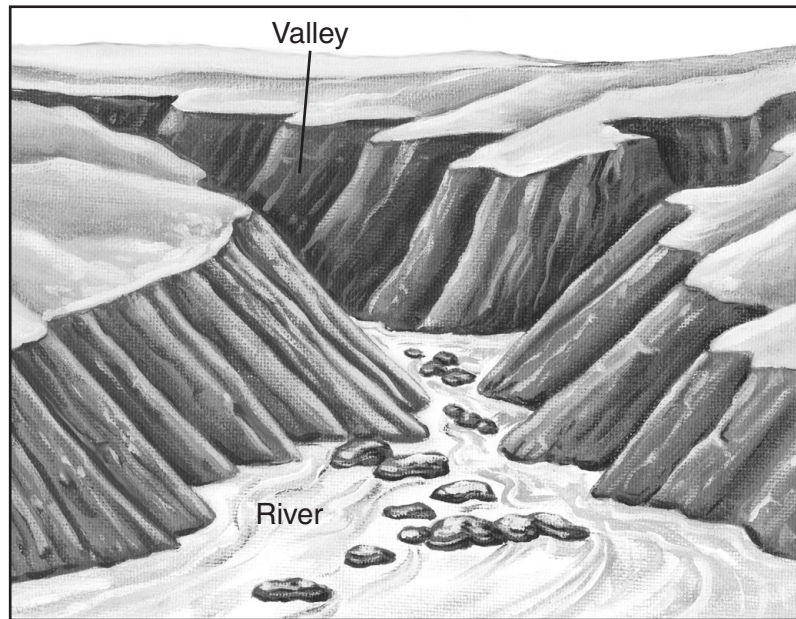

Which process caused the river valley to form?

- A evaporation
- B erosion
- C deposition
- D condensation

Note that question 22 has only three choices.

22 The diagram below shows a plastic cup floating in a container of water.

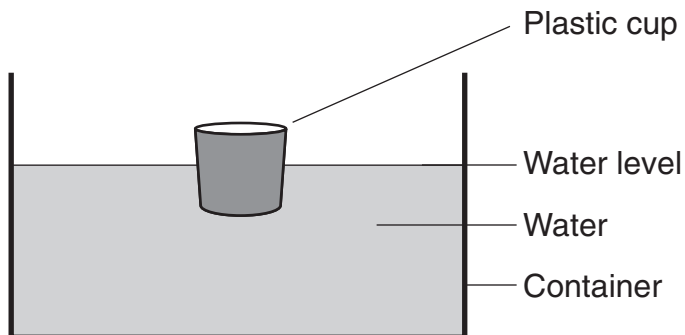

If some marbles are placed in the cup, the water level will

- A decrease
- B increase
- C remain the same

- 23** The diagram below shows three plants hanging over a table. A student watered the plants and observed water on the top of the table. The next day, the student noticed that there was no water on the table.

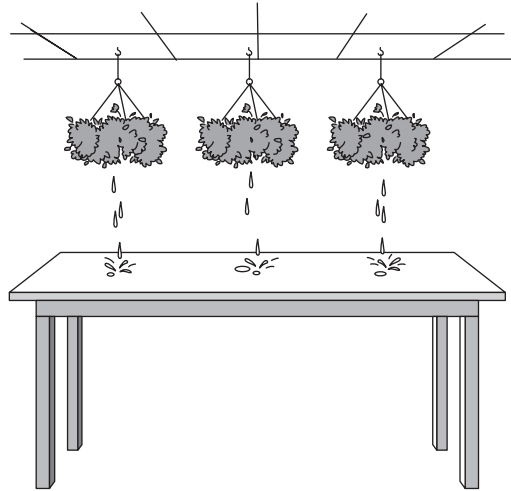

What process had occurred?

- A condensation
 - B erosion
 - C evaporation
 - D precipitation
- 24** When a person speaks into a telephone, sound energy is changed mostly into which form of energy?
- A heat
 - B light
 - C electrical
 - D chemical
- 25** A car skids along the road and smoke appears to be coming from under the tires. The heat that produces the smoke is caused by
- A magnetism
 - B sound
 - C light
 - D friction

26 In which example could a thermometer be used to show that heat energy is being transferred?

- A A piano is played by striking the keys.
- B A shovel is used to move dirt from one place to another.
- C A ball is thrown into the air.
- D A stove is used to boil water in a pan.

27 An electrical circuit is shown below.

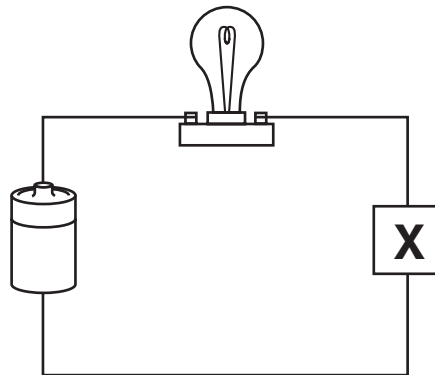

Which object at *X* will complete the circuit?

- A a metal paper clip
- B a plastic bottle
- C a rubber band
- D a wooden stick

28 When a baby shakes a rattle, it makes a noise. Which form of energy was changed to sound energy?

- A electrical
- B light
- C mechanical
- D heat

29 A ball is tossed up in the air and it comes back down. The ball comes back down because of

- A gravity
- B friction
- C erosion
- D magnetism

30 A simple machine that helps move a flag up a flagpole is

- A a bar magnet
- B an inclined plane
- C a pulley
- D a lever

GO RIGHT ON TO PART II ⇨

Part II

Directions (31–40): Record your answers in the space below each question.

31 A fourth grade class visited a pond. They saw a green frog, a beaver, and a smooth, brown snake. The teacher thought the frog was pretty. The students used nets to catch pond insects. The students looked at several insects. They counted six legs on each insect. Some students thought the insects looked scary.

a Identify **one** opinion that is stated in the paragraph. [1]

b Identify **two** observations that are stated in the paragraph. [2]

(1) _____

(2) _____

32 Place a number (2, 3, or 4) on the line below each diagram to show the order of the four stages in the life cycle of a butterfly. Stage 1 is already numbered. [1]



Adult (Butterfly)



Egg

1



Pupa (Chrysalis)



Larva (Caterpillar)

33 The diagram below shows three parts of a plant.

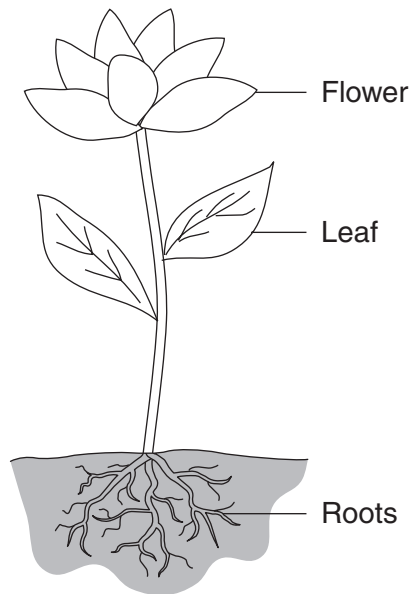

Complete the chart below by matching each plant part with its function. [2]

Function	Plant Part
uses sunlight to make food	
takes in water and nutrients	
produces seeds	

34 After walking in a field, a student found seeds stuck to his clothing. He knows this is one way seeds can be dispersed. Explain **one other** way that seeds can be dispersed. [1]

Base your answers to questions 35 and 36 on the diagrams below and on your knowledge of science. The diagrams show the same piece of land in the summer of 2002 and the summer of 2003 after the trees were cut down.



Summer 2002

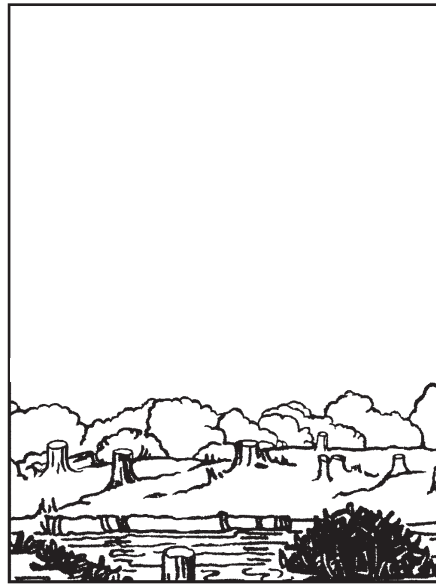

Summer 2003

35 Describe **one positive** thing that might result from cutting down the trees. [1]

36 Describe **one negative** thing that might result from cutting down the trees. [1]

Base your answers to questions 37 and 38 on the information and graph below.

A student planted twenty identical flower seeds, ten seeds in pot *A* and ten seeds in pot *B*. Both pots had the same type and amount of soil. Both pots received equal amounts of sunlight and water. When the plants started to grow, the student pulled out all but two plants in pot *A*. She left all ten plants in pot *B*. The graph shows the average height of the plants in each pot after 30 days.

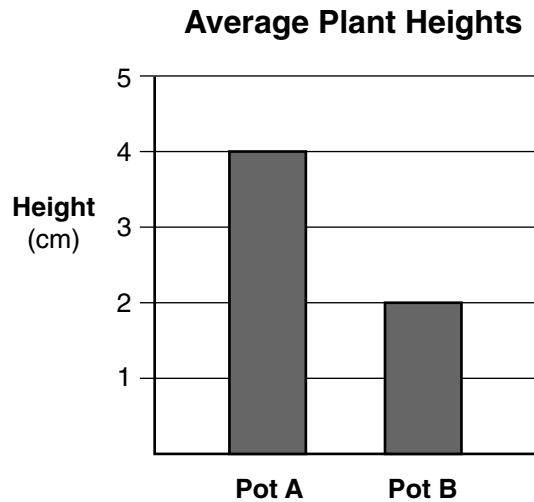

37 What is the difference in the average height of the plants in pot *A* and pot *B*? [1]

_____ **cm**

38 Explain why there is a difference in average height between the plants in pot *A* and pot *B*. [1]

39 The data table below shows the temperature, type of precipitation, and sky condition for three cities in New York State at noon on November 15.

Data Table

City	Temperature (°F)	Type of Precipitation	Sky Condition
Albany	45	rain	cloudy
Massena	27	snow	cloudy
Buffalo	42	none	sunny and clear

Explain why the precipitation in Massena is snow. [1]

40 Students use tools to measure the properties of objects. The chart below shows some properties, tools, and metric units of measurement.

Property	Tool	Metric Unit of Measurement
mass	balance	g
length	ruler	
	graduated cylinder	mL
temperature		°C

Complete the chart by filling in the three shaded boxes with the correct property, tool, and metric unit of measurement. [3]

For Teacher Use Only
Part II Credit

Question	Maximum Credit	Credit Allowed
31	3	
32	1	
33	2	
34	1	
35	1	
36	1	
37	1	
38	1	
39	1	
40	3	
Total	15	